

Ramachandrapuram, Andhra Pradesh, India  
vsm College, Ramachandrapuram, Andhra Pradesh 533255,  
India  
Lat N 16° 50' 28.7628"  
Long E 82° 1' 6.906"  
21/03/21 11:32 AM

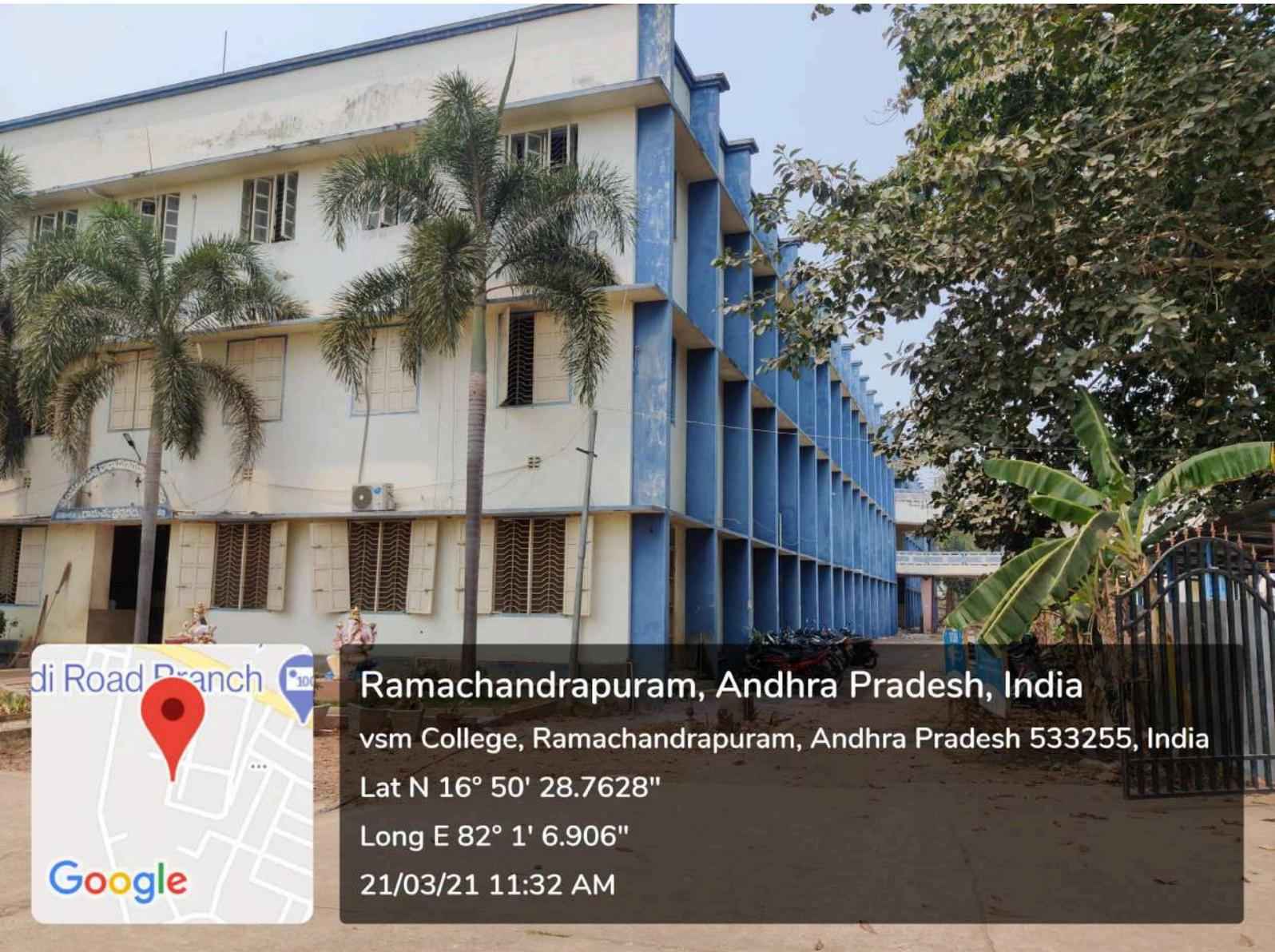

di Road Branch

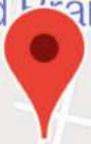

Google

**Ramachandrapuram, Andhra Pradesh, India**

vsm College, Ramachandrapuram, Andhra Pradesh 533255, India

Lat N 16° 50' 28.7628"

Long E 82° 1' 6.906"

21/03/21 11:32 AM

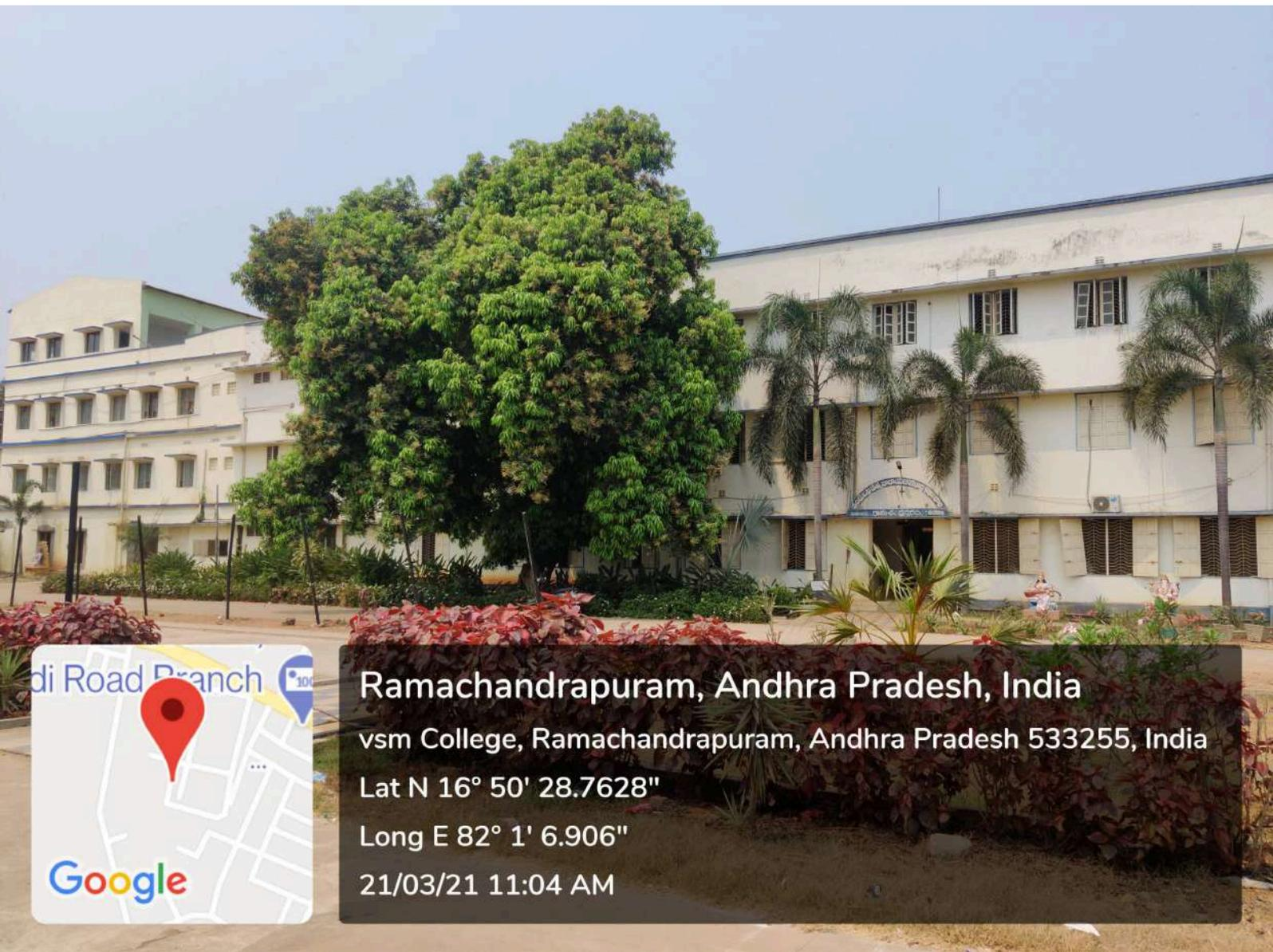

**Ramachandrapuram, Andhra Pradesh, India**  
vsm College, Ramachandrapuram, Andhra Pradesh 533255, India  
Lat N 16° 50' 28.7628"  
Long E 82° 1' 6.906"  
21/03/21 11:04 AM

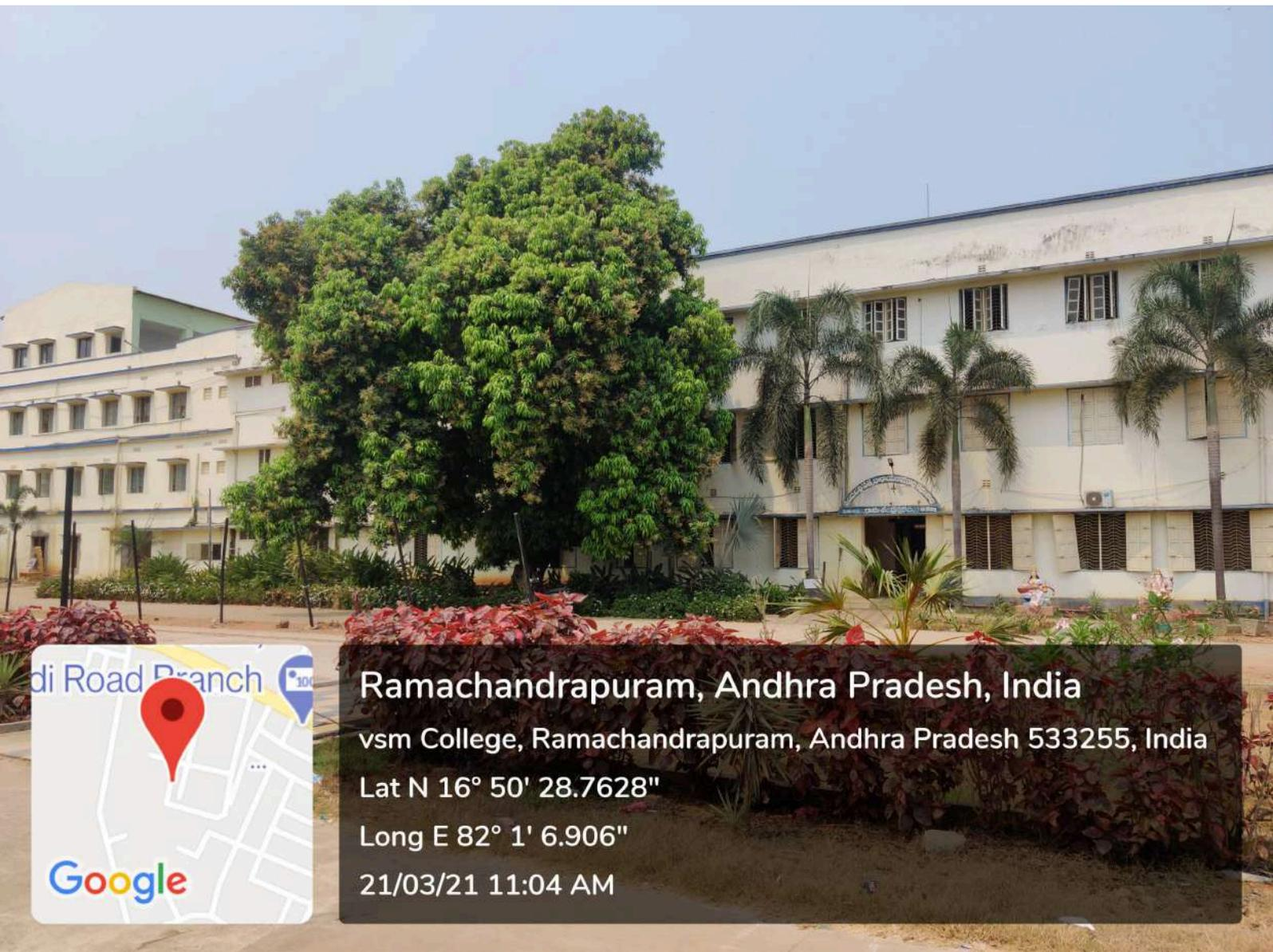

Ramachandrapuram, Andhra Pradesh, India  
vsm College, Ramachandrapuram, Andhra Pradesh 533255, India  
Lat N 16° 50' 28.7628"  
Long E 82° 1' 6.906"  
21/03/21 11:04 AM



Ramachandrapuram, Andhra Pradesh, India

vsm College, Ramachandrapuram, Andhra Pradesh 533255, India

Lat N 16° 50' 28.7628"

Long E 82° 1' 6.906"

21/03/21 11:03 AM



Ramachandrapuram, Andhra Pradesh, India

vsm College, Ramachandrapuram, Andhra Pradesh 533255, India

Lat N 16° 50' 28.7628"

Long E 82° 1' 6.906"

21/03/21 11:02 AM



di Road Branch

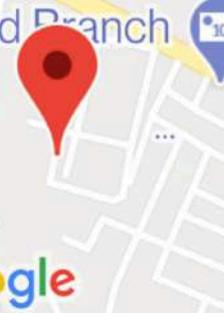

Google

Ramachandrapuram, Andhra Pradesh, India  
vsm College, Ramachandrapuram, Andhra Pradesh 533255, India  
Lat N 16° 50' 28.7628"  
Long E 82° 1' 6.906"  
21/03/21 10:51 AM



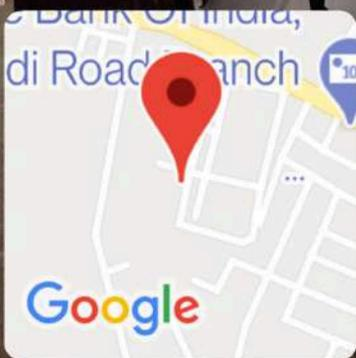

**Ramachandrapuram, Andhra Pradesh, India**  
Om Sri Towers Rd, Ramachandrapuram, Andhra Pradesh 533255, India  
Lat N 16° 50' 29.4468"  
Long E 82° 1' 6.6288"  
21/03/21 10:45 AM

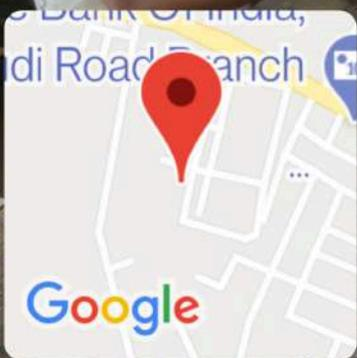

**Ramachandrapuram, Andhra Pradesh, India**

Om Sri Towers Rd, Ramachandrapuram, Andhra Pradesh 533255, India

Lat N 16° 50' 29.3172"

Long E 82° 1' 6.4236"

21/03/21 10:41 AM

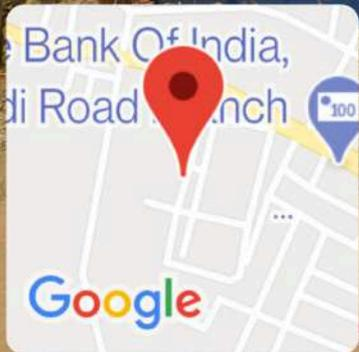

**Ramachandrapuram, Andhra Pradesh, India**

Om Sri Towers Rd, Ramachandrapuram, Andhra Pradesh 533255, India

Lat N 16° 50' 31.5132"

Long E 82° 1' 7.2984"

21/03/21 10:31 AM



## Ramachandrapuram, Andhra Pradesh, India

VSM College, Ramachandrapuram Rd, Ramachandrapuram, Andhra Pradesh  
533255, India

Lat N 16° 50' 33.4464"

Long E 82° 1' 5.556"

21/03/21 10:22 AM



## Ramachandrapuram, Andhra Pradesh, India

VSM College, Ramachandrapuram Rd, Ramachandrapuram, Andhra Pradesh 533255, India

Lat N 16° 50' 33.8892"

Long E 82° 1' 4.9872"

15/03/21 04:24 PM



**Ramachandrapuram, Andhra Pradesh, India**

VSM College, Ramachandrapuram Rd, Ramachandrapuram, Andhra Pradesh 533255, India

Lat N 16° 50' 33.8712"

Long E 82° 1' 5.3292"

15/03/21 04:28 PM



## Ramachandrapuram, Andhra Pradesh, India

VSM College, Ramachandrapuram Rd, Ramachandrapuram, Andhra Pradesh 533255, India

Lat N 16° 50' 33.8352"

Long E 82° 1' 5.3616"

15/03/21 04:09 PM



### Ramachandrapuram, Andhra Pradesh, India

VSM College, Ramachandrapuram Rd, Ramachandrapuram, Andhra Pradesh 533255, India

Lat N 16° 50' 33.4968"

Long E 82° 1' 4.8756"

15/03/21 04:09 PM



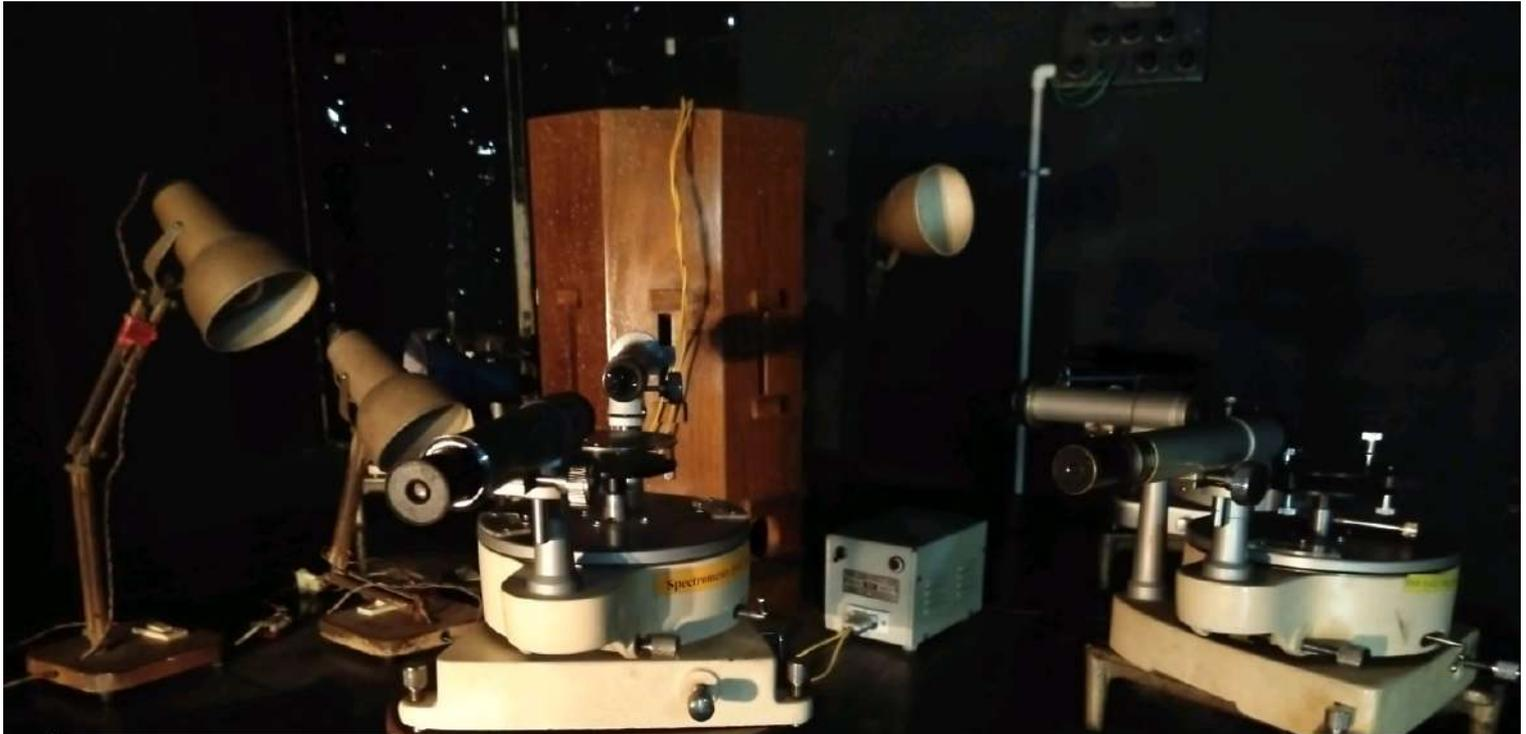

## Ramachandrapuram, Andhra Pradesh, India

VSM College, Ramachandrapuram Rd, Ramachandrapuram, Andhra Pradesh 533255, India

Lat N 16° 50' 33.4968"

Long E 82° 1' 4.8756"

15/03/21 04:09 PM



**Ramachandrapuram, Andhra Pradesh, India**

**VSM College, Ramachandrapuram Rd,**

**Ramachandrapuram, Andhra Pradesh 533255, India**

**Lat N 16° 50' 33.4968"**

**Long E 82° 1' 4.8756"**

**15/03/21 04:11 PM**



**Ramachandrapuram, Andhra Pradesh, India**

VSM College, Ramachandrapuram Rd, Ramachandrapuram, Andhra Pradesh 533255, India

Lat N 16° 50' 33.4968"

Long E 82° 1' 4.8756"

15/03/21 04:12 PM



## Ramachandrapuram, Andhra Pradesh, India

VSM College, Ramachandrapuram Rd, Ramachandrapuram, Andhra Pradesh 533255, India

Lat N 16° 50' 33.4968"

Long E 82° 1' 4.8756"

15/03/21 04:13 PM

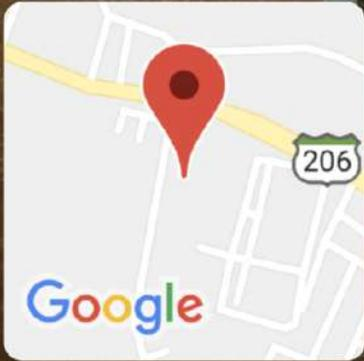

## Ramachandrapuram, Andhra Pradesh, India

VSM College, Ramachandrapuram Rd, Ramachandrapuram, Andhra Pradesh 533255, India

Lat N 16° 50' 33.4968"

Long E 82° 1' 4.8756"

15/03/21 04:13 PM



**PLANCK'S CONSTANT APPARATUS**



MAINS ON



MICRO-AMMETER



VOLTMETER



2 VOLTS

OUTPUT

**Ramachandrapuram, Andhra Pradesh, India**

VSM College, Ramachandrapuram Rd, Ramachandrapuram, Andhra Pradesh 533255, India

Lat N 16° 50' 34.5552"

Long E 82° 1' 5.3652"

15/03/21 04:15 PM



Google





e/m BY THOMPSON METHOD

Ramachandrapuram, Andhra Pradesh, India

Ramachandrapuram Rd, Ramachandrapuram, Andhra Pradesh

533255, India

Lat N  $16^{\circ} 50' 42.9612''$

Long E  $82^{\circ} 1' 3.8028''$

15/03/21 04:16 PM



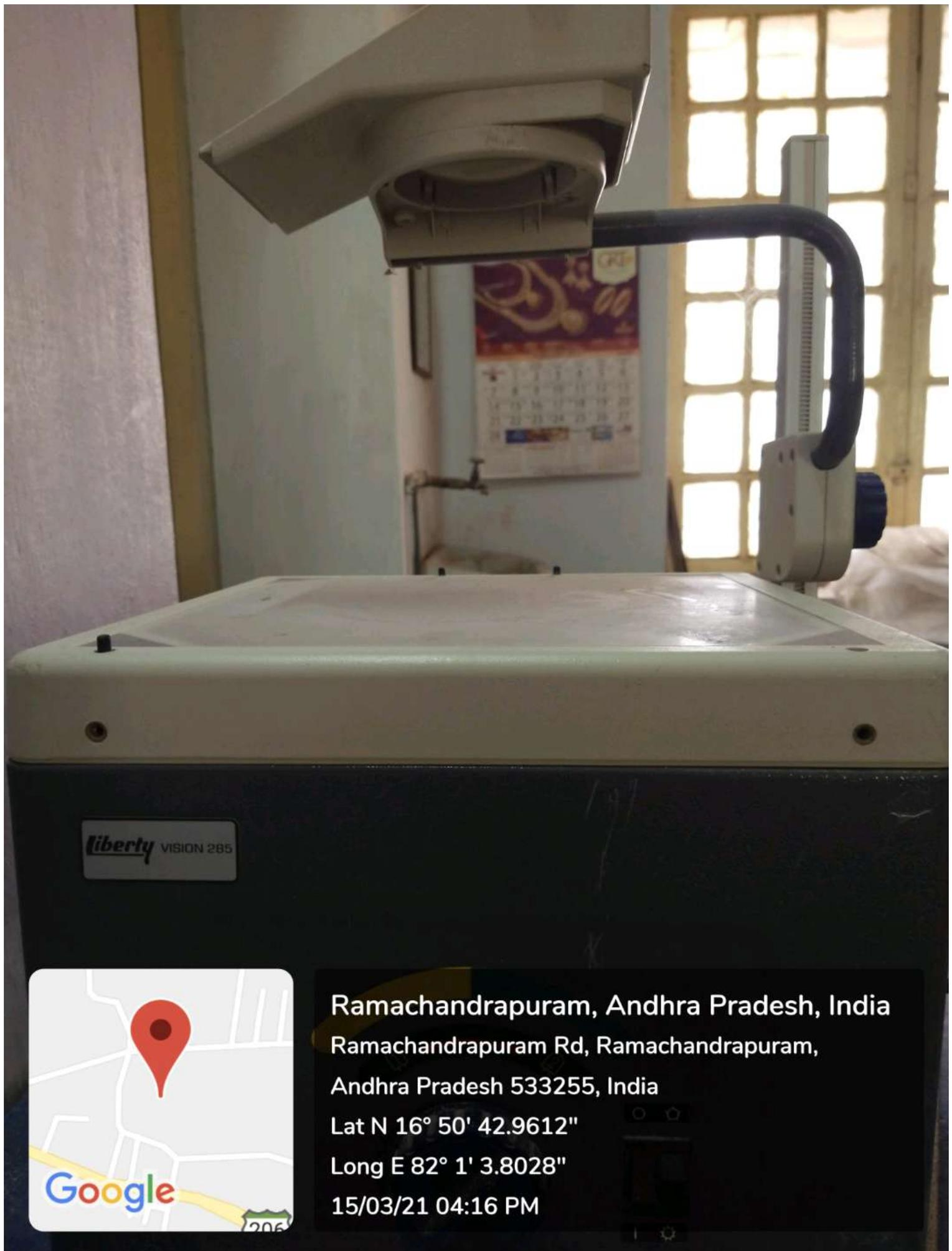

*liberty* VISION 285



**Ramachandrapuram, Andhra Pradesh, India**

Ramachandrapuram Rd, Ramachandrapuram,

Andhra Pradesh 533255, India

Lat N 16° 50' 42.9612"

Long E 82° 1' 3.8028"

15/03/21 04:16 PM



## Ramachandrapuram, Andhra Pradesh, India

VSM College, Ramachandrapuram Rd, Ramachandrapuram, Andhra Pradesh 533255, India

Lat N 16° 50' 33.7668"

Long E 82° 1' 5.2824"

15/03/21 04:18 PM



**Ramachandrapuram, Andhra Pradesh, India**

VSM College, Ramachandrapuram Rd, Ramachandrapuram, Andhra Pradesh 533255, India

Lat N 16° 50' 33.8424"

Long E 82° 1' 5.3652"

15/03/21 04:18 PM

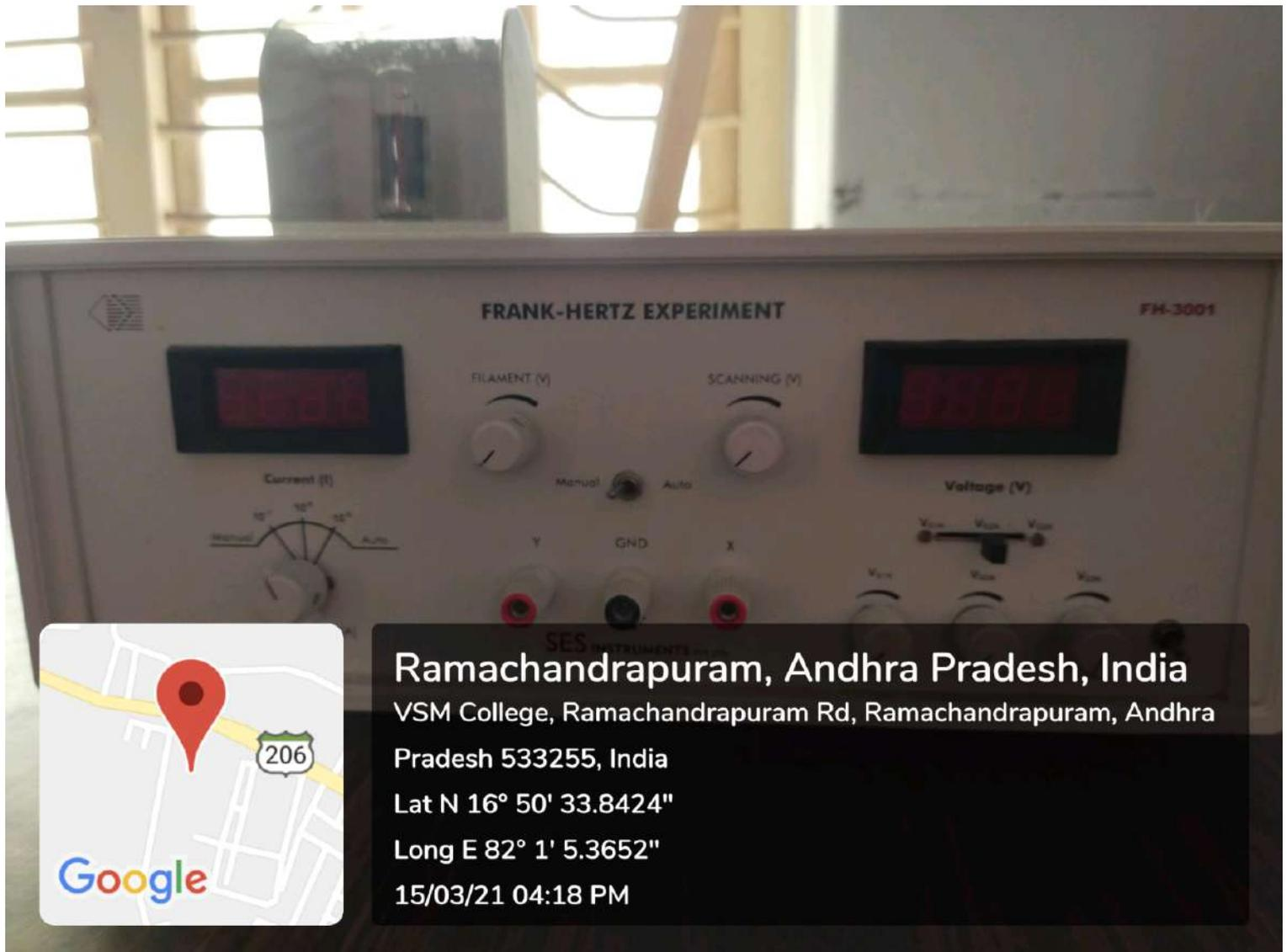

## Ramachandrapuram, Andhra Pradesh, India

VSM College, Ramachandrapuram Rd, Ramachandrapuram, Andhra Pradesh 533255, India

Lat N 16° 50' 33.8424"

Long E 82° 1' 5.3652"

15/03/21 04:18 PM





PACIFIC 30MHz OSCILLOSCOPE P0S 2030

Ramachandrapuram, Andhra Pradesh, India  
VSM College, Ramachandrapuram Rd,  
Ramachandrapuram, Andhra Pradesh 533255, India  
Lat N 16° 50' 33.8424"  
Long E 82° 1' 5.376"  
15/03/21 04:18 PM





Ramachandrapuram, Andhra Pradesh, India

VSM College, Ramachandrapuram Rd,

Ramachandrapuram, Andhra Pradesh 533255, India

Lat N 16° 50' 33.846"

Long E 82° 1' 5.358"

15/03/21 04:19 PM



**Ramachandrapuram, Andhra Pradesh, India**

VSM College, Ramachandrapuram Rd, Ramachandrapuram, Andhra Pradesh 533255, India

Lat N 16° 50' 33.846"

Long E 82° 1' 5.358"

15/03/21 04:19 PM



Ramachandrapuram, Andhra Pradesh, India  
VSM College, Ramachandrapuram Rd,  
Ramachandrapuram, Andhra Pradesh 533255, India  
Lat N 16° 50' 33.846"  
Long E 82° 1' 5.358"  
15/03/21 04:19 PM





## Ramachandrapuram, Andhra Pradesh, India

VSM College, Ramachandrapuram Rd, Ramachandrapuram, Andhra Pradesh 533255, India

Lat N 16° 50' 33.846"

Long E 82° 1' 5.358"

15/03/21 04:20 PM



Ramachandrapuram, Andhra Pradesh, India  
VSM College, Ramachandrapuram Rd,  
Ramachandrapuram, Andhra Pradesh 533255, India  
Lat N 16° 50' 33.846"  
Long E 82° 1' 5.358"  
15/03/21 04:20 PM

physitech  
ELECTRONICS

FREQUENCY MODULATION AND DEMODULATION USING PLL

PHY 138

FM MODULATOR

FM DE-MODULATOR

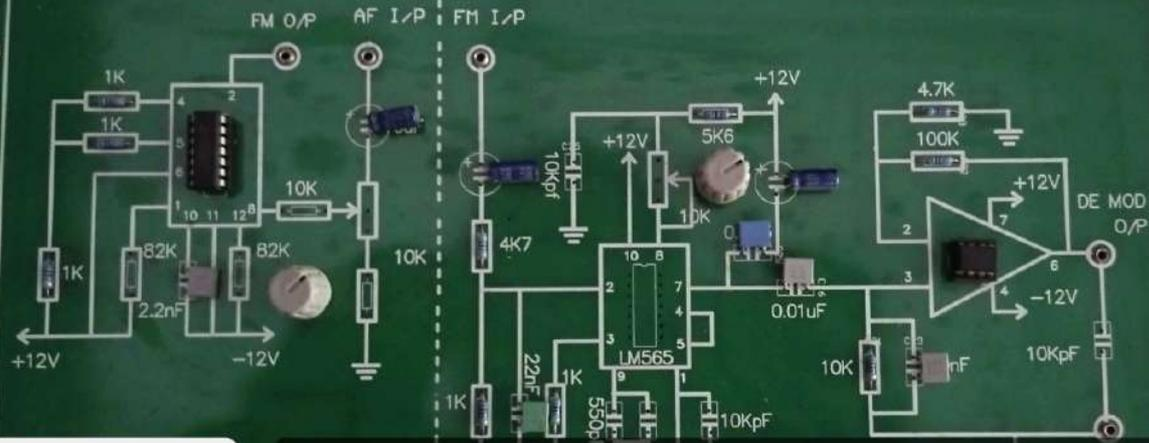

**Ramachandrapuram, Andhra Pradesh, India**

VSM College, Ramachandrapuram Rd, Ramachandrapuram, Andhra Pradesh 533255, India

Lat N 16° 50' 33.846"

Long E 82° 1' 5.358" | Email : physitech@yahoo.com | PHONE:27537483,27547483

15/03/21 04:20 PM



STUDY OF DIELECTRIC CONSTANT

DEC-01

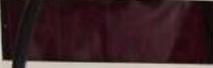

Capacitance (pf)



Temperature (°C)

OVEN  
On Off

Probe Terminals

RTD

Oven

Set Temp



Ramachandrapuram, Andhra Pradesh, India

VSM College, Ramachandrapuram Rd, Ramachandrapuram, Andhra Pradesh 533255, India

Lat N 16° 50' 33.846"

Long E 82° 1' 5.358"

15/03/21 04:21 PM

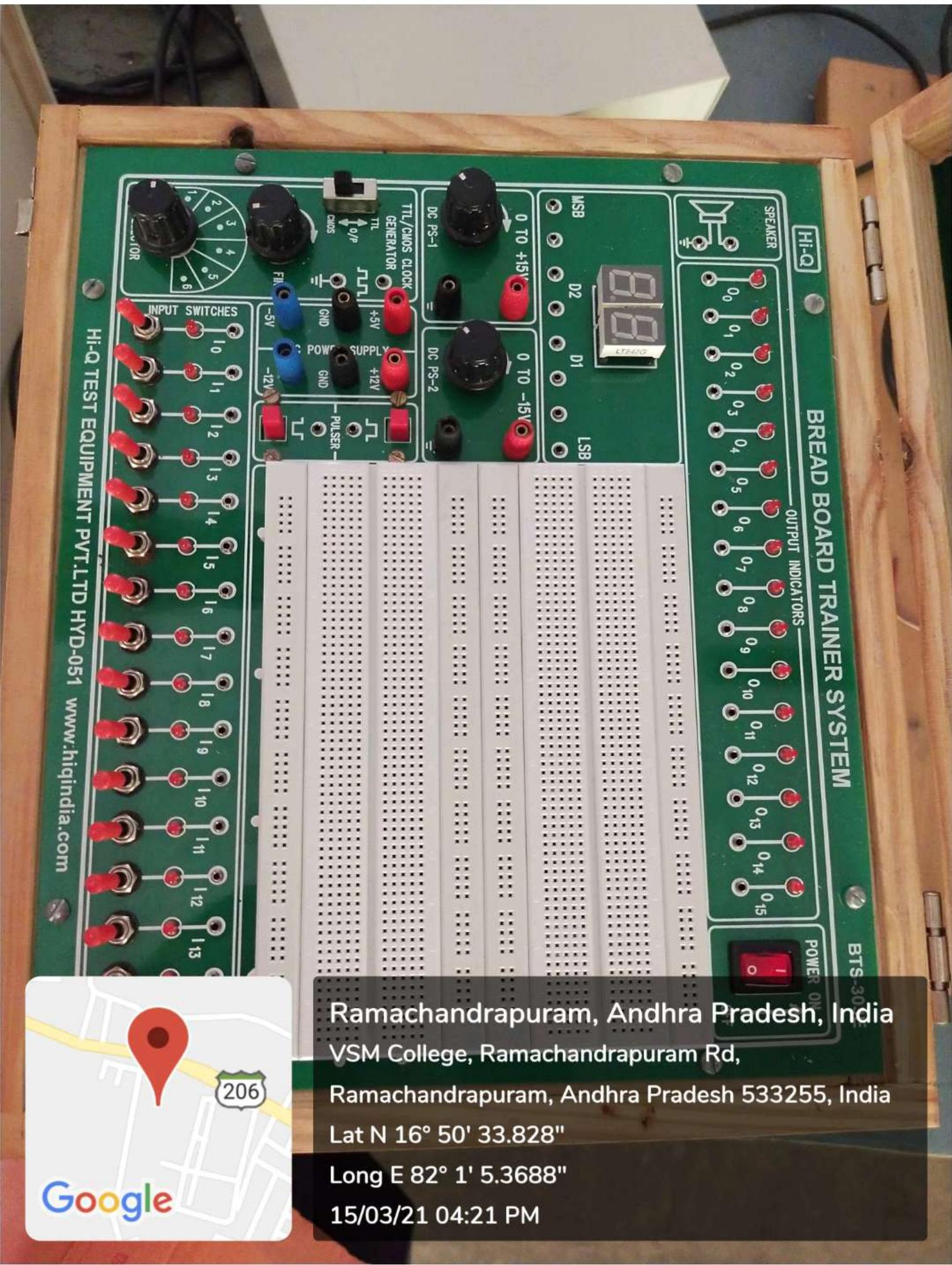

Ramachandrapuram, Andhra Pradesh, India  
VSM College, Ramachandrapuram Rd,  
Ramachandrapuram, Andhra Pradesh 533255, India  
Lat N 16° 50' 33.828"  
Long E 82° 1' 5.3688"  
15/03/21 04:21 PM



Ramachandrapuram, Andhra Pradesh, India

MDR94, Ramachandrapuram, Andhra Pradesh 533287, India

Lat N 16° 50' 47.4864"

Long E 82° 1' 18.5196"

15/03/21 04:22 PM



### Ramachandrapuram, Andhra Pradesh, India

VSM College, Ramachandrapuram Rd, Ramachandrapuram, Andhra Pradesh 533255, India

Lat N 16° 50' 33.9432"

Long E 82° 1' 7.3776"

15/03/21 03:38 PM



Bank C... dia,  
i Road B... anch

Ramachandrapuram, Andhra Pradesh, India  
VSM College, Ramachandrapuram Rd,  
Ramachandrapuram, Andhra Pradesh 533255, India  
Lat N 16° 50' 34.0188"  
Long E 82° 1' 7.6332"  
15/03/21 03:40 PM





VSM



Ramachandrapuram, Andhra Pradesh, India

VSM College, Ramachandrapuram Rd,

Ramachandrapuram, Andhra Pradesh 533255, India

Lat N 16° 50' 33.9216"

Long E 82° 1' 7.6476"

15/03/21 03:41 PM

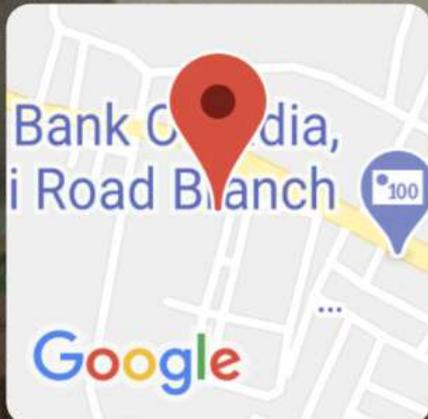

Ramachandrapuram, Andhra Pradesh, India

VSM College, Ramachandrapuram Rd,

Ramachandrapuram, Andhra Pradesh 533255, India

Lat N 16° 50' 33.8424"

Long E 82° 1' 7.6332"

15/03/21 03:41 PM



Ramachandrapuram, Andhra Pradesh, India

VSM College, Ramachandrapuram Rd,

Ramachandrapuram, Andhra Pradesh 533255, India

Lat N 16° 50' 33.7848"

Long E 82° 1' 7.6008"

15/03/21 03:41 PM



Ramachandrapuram, Andhra Pradesh, India

VSM College, Ramachandrapuram Rd,

Ramachandrapuram, Andhra Pradesh 533255, India

Lat N 16° 50' 33.9432"

Long E 82° 1' 7.5576"

15/03/21 03:42 PM



Ramachandrapuram, Andhra Pradesh, India  
VSM College, Ramachandrapuram Rd,  
Ramachandrapuram, Andhra Pradesh 533255, India  
Lat N 16° 50' 33.774"  
Long E 82° 1' 7.5468"  
15/03/21 03:42 PM



Bank C...dia,  
i Road Branch

Google

Ramachandrapuram, Andhra Pradesh, India

VSM College, Ramachandrapuram Rd,

Ramachandrapuram, Andhra Pradesh 533255, India

Lat N 16° 50' 33.7272"

Long E 82° 1' 7.5144"

15/03/21 03:42 PM



Bank C...dia,  
i Road Branch

Google

Ramachandrapuram, Andhra Pradesh, India  
VSM College, Ramachandrapuram Rd,  
Ramachandrapuram, Andhra Pradesh 533255, India  
Lat N 16° 50' 33.6912"  
Long E 82° 1' 7.5216"  
15/03/21 03:43 PM



Ramachandrapuram, Andhra Pradesh, India

VSM College, Ramachandrapuram Rd,

Ramachandrapuram, Andhra Pradesh 533255, India

Lat N 16° 50' 33.7128"

Long E 82° 1' 7.5432"

15/03/21 03:43 PM



Magnetic stirrer

1 MLH MAGNETIC STIRRER

REMI



HEAT



Bank C...dia,  
i Road Branch

Google

Ramachandrapuram, Andhra Pradesh, India

VSM College, Ramachandrapuram Rd,

Ramachandrapuram, Andhra Pradesh 533255, India

Lat N 16° 50' 33.7416"

Long E 82° 1' 7.5432"

15/03/21 03:43 PM



Ramachandrapuram, Andhra Pradesh, India  
VSM College, Ramachandrapuram Rd,  
Ramachandrapuram, Andhra Pradesh 533255, India  
Lat N 16° 50' 32.5608"  
Long E 82° 1' 7.4892"  
15/03/21 03:44 PM



Ramachandrapuram, Andhra Pradesh, India

VSM College, Ramachandrapuram Rd,

Ramachandrapuram, Andhra Pradesh 533255, India

Lat N 16° 50' 33.8712"

Long E 82° 1' 5.7144"

15/03/21 03:50 PM



Ramachandrapuram, Andhra Pradesh, India

VSM College, Ramachandrapuram Rd,

Ramachandrapuram, Andhra Pradesh 533255, India

Lat N 16° 50' 34.0692"

Long E 82° 1' 5.7432"

15/03/21 03:51 PM



Ramachandrapuram, Andhra Pradesh, India

Ramachandrapuram Rd, Ramachandrapuram,

Andhra Pradesh 533255, India

Lat N 16° 50' 30.642"

Long E 82° 1' 25.878"

15/03/21 03:51 PM



Ramachandrapuram, Andhra Pradesh, India

Ramachandrapuram Rd, Ramachandrapuram,

Andhra Pradesh 533255, India

Lat N 16° 50' 34.1196"

Long E 82° 1' 13.6128"

15/03/21 03:52 PM



**EQUIP-TRONICS** MODEL-EQ-601  
DIGITAL POTENTIOMETER WITH IN BUILT  
STD CELL

8888

**SELF CHECK**

THROW THE SWITCH DOWN TO  
BRING IN STD CELL OF 1.018 V  
CALIBRATE THE INSTRUMENT  
AND THROW THE SWITCH UP TO  
CUT OUT STD CELL

CELL IN

← CALIBRATE



Ramachandrapuram, Andhra Pradesh, India

Ramachandrapuram Rd, Ramachandrapuram,

Andhra Pradesh 533255, India

Lat N 16° 50' 34.1196"

Long E 82° 1' 13.6128"

15/03/21 03:52 PM



Ramachandrapuram, Andhra Pradesh, India

Ramachandrapuram Rd, Ramachandrapuram,

Andhra Pradesh 533255, India

Lat N 16° 50' 34.1196"

Long E 82° 1' 13.6128"

15/03/21 03:52 PM





**Ramachandrapuram, Andhra Pradesh, India**

Ramachandrapuram Rd, Ramachandrapuram, Andhra Pradesh  
533255, India

Lat N 16° 50' 34.1196"

Long E 82° 1' 13.6128"

15/03/21 03:53 PM



## Ramachandrapuram, Andhra Pradesh, India

VSM College, Ramachandrapuram Rd, Ramachandrapuram, Andhra Pradesh 533255, India

Lat N 16° 50' 33.0324"

Long E 82° 1' 5.2212"

15/03/21 03:53 PM



CL 157  
COLORIMETER

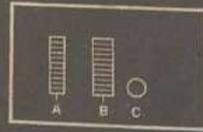

INSTRUCTIONS

- SELECT FILTER B
- PLACE CELL/TEST TUBE WITH BLANK C
- ADJUST A FOR ZERO OD
- REPLACE BLANK WITH SAMPLE IN C
- READ OD



Ramachandrapuram, Andhra Pradesh, India

VSM College, Ramachandrapuram Rd,

Ramachandrapuram, Andhra Pradesh 533255, India

Lat N 16° 50' 32.6652"

Long E 82° 1' 5.7828"

15/03/21 03:53 PM

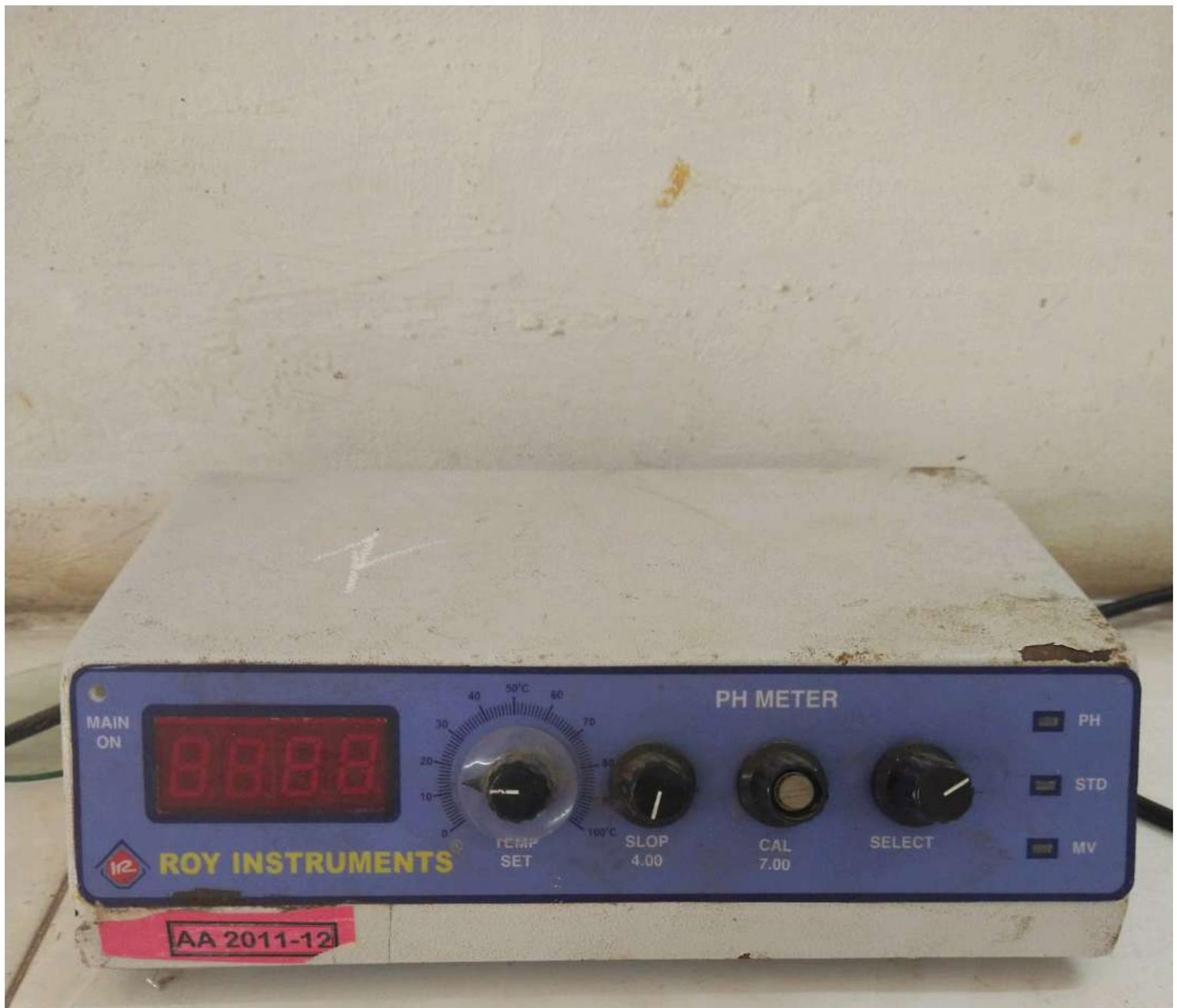

Ramachandrapuram, Andhra Pradesh, India

VSM College, Ramachandrapuram Rd,

Ramachandrapuram, Andhra Pradesh 533255, India

Lat N 16° 50' 32.6472"

Long E 82° 1' 5.7396"

15/03/21 03:54 PM



Ramachandrapuram, Andhra Pradesh, India  
VSM College, Ramachandrapuram Rd,  
Ramachandrapuram, Andhra Pradesh 533255, India  
Lat N 16° 50' 32.7012"  
Long E 82° 1' 5.6928"  
15/03/21 03:54 PM

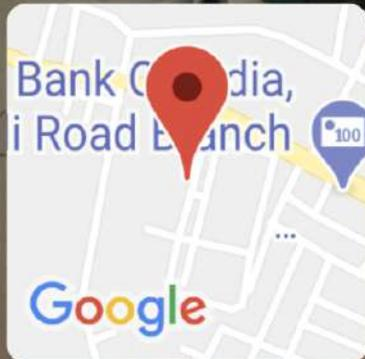
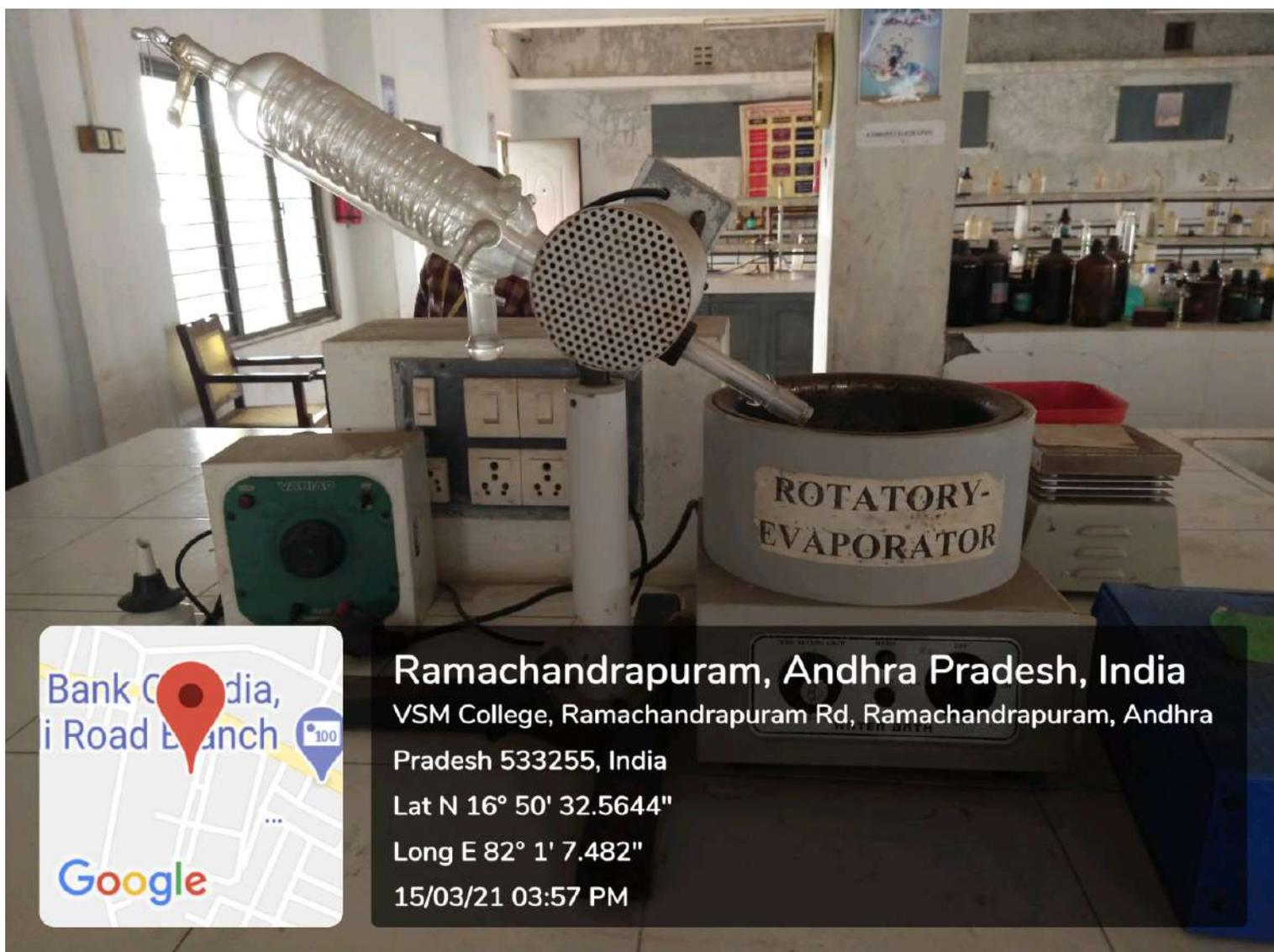

## Ramachandrapuram, Andhra Pradesh, India

VSM College, Ramachandrapuram Rd, Ramachandrapuram, Andhra Pradesh 533255, India

Lat N 16° 50' 32.5644"

Long E 82° 1' 7.482"

15/03/21 03:57 PM



Bank C... dia,  
i Road Branch

Google

Ramachandrapuram, Andhra Pradesh, India

VSM College, Ramachandrapuram Rd,

Ramachandrapuram, Andhra Pradesh 533255, India

Lat N 16° 50' 32.5644"

Long E 82° 1' 7.482"

15/03/21 03:58 PM



Ramachandrapuram, Andhra Pradesh, India  
VSM College, Ramachandrapuram Rd,  
Ramachandrapuram, Andhra Pradesh 533255, India  
Lat N 16° 50' 32.5644"  
Long E 82° 1' 7.482"  
15/03/21 04:00 PM





Ramachandrapuram, Andhra Pradesh, India  
VSM College, Ramachandrapuram Rd,  
Ramachandrapuram, Andhra Pradesh 533255, India  
Lat N 16° 50' 32.5644"  
Long E 82° 1' 7.482"  
15/03/21 04:01 PM



Ramachandrapuram, Andhra Pradesh, India

MDR94, Ramachandrapuram, Andhra Pradesh

533287, India

Lat N 16° 50' 43.944"

Long E 82° 0' 55.2204"

15/03/21 04:01 PM



Ramachandrapuram, Andhra Pradesh, India

Ramachandrapuram Rd, Ramachandrapuram,

Andhra Pradesh 533255, India

Lat N 16° 50' 42.7452"

Long E 82° 0' 57.6864"

15/03/21 04:02 PM



-CHAMBER



Ramachandrapuram, Andhra Pradesh, India

Ramachandrapuram Rd, Ramachandrapuram,

Andhra Pradesh 533255, India

Lat N 16° 50' 42.54"

Long E 82° 0' 58.8168"

15/03/21 04:02 PM



**Ramachandrapuram, Andhra Pradesh, India**  
VSM College, Ramachandrapuram Rd, Ramachandrapuram, Andhra Pradesh 533255, India  
Lat N 16° 50' 32.9568"  
Long E 82° 1' 6.3516"  
15/03/21 04:02 PM

U G C XI Plan - Zoology - Hotair Oven



Ramachandrapuram, Andhra Pradesh, India

VSM College, Ramachandrapuram Rd,

Ramachandrapuram, Andhra Pradesh 533255, India

Lat N 16° 50' 34.1736"

Long E 82° 1' 5.3112"

15/03/21 03:29 PM



Ramachandrapuram, Andhra Pradesh, India  
VSM College, Ramachandrapuram Rd,  
Ramachandrapuram, Andhra Pradesh 533255, India  
Lat N 16° 50' 34.1232"  
Long E 82° 1' 4.9728"  
15/03/21 03:29 PM



Ramachandrapuram, Andhra Pradesh, India

VSM College, Ramachandrapuram Rd,

Ramachandrapuram, Andhra Pradesh 533255, India

Lat N 16° 50' 34.6956"

Long E 82° 1' 4.8972"

15/03/21 03:29 PM





Ramachandrapuram, Andhra Pradesh, India

VSM College, Ramachandrapuram Rd,

Ramachandrapuram, Andhra Pradesh 533255, India

Lat N 16° 50' 34.7496"

Long E 82° 1' 4.9152"

15/03/21 03:30 PM



Ramachandrapuram, Andhra Pradesh, India

VSM College, Ramachandrapuram Rd,

Ramachandrapuram, Andhra Pradesh 533255, India

Lat N 16° 50' 34.7604"

Long E 82° 1' 4.9584"

15/03/21 03:30 PM



COLOURI METER

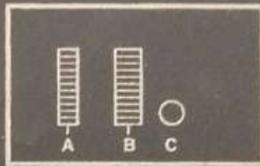

**INSTRUCTIONS**

- SELECT FILTER B
- PLACE CELL/TEST TUBE WITH BLANK C
- ADJUST A FOR ZERO OD
- REPLACE BLANK WITH SAMPLE IN C
- READ OD



**CL 157**  
**COLORIMETER**



**Ramachandrapuram, Andhra Pradesh, India**

VSM College, Ramachandrapuram Rd,

Ramachandrapuram, Andhra Pradesh 533255, India

Lat N 16° 50' 34.7208"

Long E 82° 1' 4.9692"

15/03/21 03:30 PM

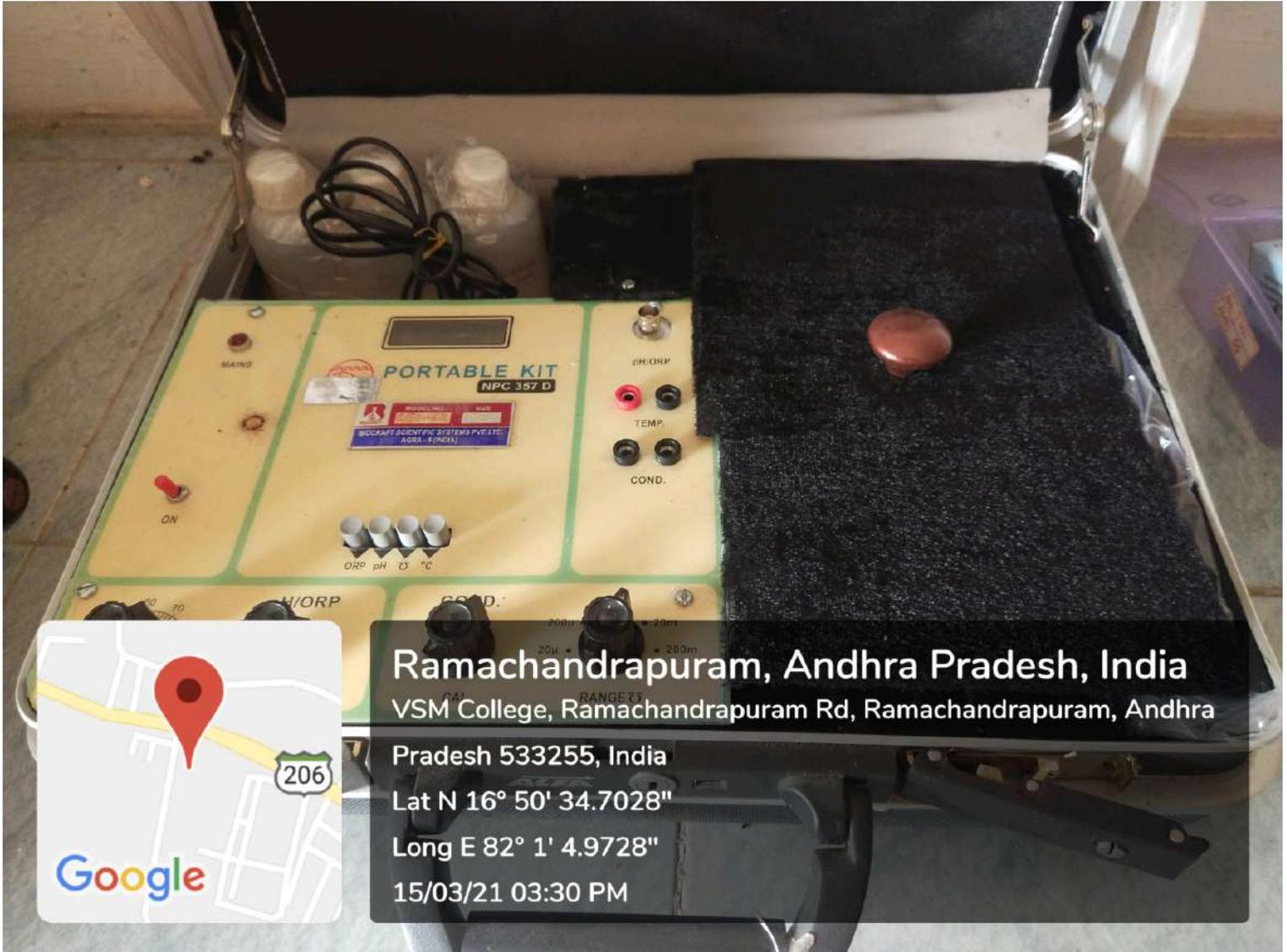

**Ramachandrapuram, Andhra Pradesh, India**

VSM College, Ramachandrapuram Rd, Ramachandrapuram, Andhra

Pradesh 533255, India

Lat N 16° 50' 34.7028"

Long E 82° 1' 4.9728"

15/03/21 03:30 PM





Ramachandrapuram, Andhra Pradesh, India

VSM College, Ramachandrapuram Rd,

Ramachandrapuram, Andhra Pradesh 533255, India

Lat N 16° 50' 34.674"

Long E 82° 1' 4.9728"

15/03/21 03:30 PM

U G C XI Plan - Zoology - Centrifuse

**WARNING**

1. READ OPERATING INSTRUCTIONS BEFORE USE
2. PROVIDE PROPER EARTHING.
3. FOR VIBRATION FREE PERFORMANCE
  - a. ENSURE LEVEL AND STABILITY
  - b. BALANCE CENTRIFUGE TUBES
  - c. ENSURE USE OF RUBBER CUSHIONS FOR GLASS TUBES
4. BRING SPEED KNOB TO "OFF" AND INCREASE SPEED GRADUALLY
5. CHECK CARBON BRUSHES PERIODICALLY
6. CHECK GLASS FUSE FOR NON-WORKING OF UNIT.

**R-8C** LABORATORY CENTRIFUGE

**REMI**



MAINS



Ramachandrapuram, Andhra Pradesh, India

VSM College, Ramachandrapuram Rd,

Ramachandrapuram, Andhra Pradesh 533255, India

Lat N 16° 50' 40.4232"

Long E 82° 1' 6.2544"

15/03/21 03:31 PM



**Ramachandrapuram, Andhra Pradesh, India**

VSM College, Ramachandrapuram Rd, Ramachandrapuram, Andhra Pradesh 533255, India

Lat N 16° 50' 40.4232"

Long E 82° 1' 6.2544"

15/03/21 03:31 PM



Ramachandrapuram, Andhra Pradesh, India

VSM College, Ramachandrapuram Rd,

Ramachandrapuram, Andhra Pradesh 533255, India

Lat N 16° 50' 40.4232"

Long E 82° 1' 6.2544"

15/03/21 03:32 PM





Ramachandrapuram, Andhra Pradesh, India

VSM College, Ramachandrapuram Rd,

Ramachandrapuram, Andhra Pradesh 533255, India

Lat N 16° 50' 40.4232"

Long E 82° 1' 6.2544"

15/03/21 03:32 PM



Ramachandrapuram, Andhra Pradesh, India

VSM College, Ramachandrapuram Rd,

Ramachandrapuram, Andhra Pradesh 533255, India

Lat N 16° 50' 40.4232"

Long E 82° 1' 6.2544"

15/03/21 03:32 PM



Ramachandrapuram, Andhra Pradesh, India  
VSM College, Ramachandrapuram Rd,  
Ramachandrapuram, Andhra Pradesh 533255, India  
Lat N 16° 50' 40.4232"  
Long E 82° 1' 6.2544"  
15/03/21 03:32 PM



Ramachandrapuram, Andhra Pradesh, India

MDR94, Ramachandrapuram, Andhra Pradesh

533287, India

Lat N 16° 50' 39.8976"

Long E 82° 0' 52.7652"

15/03/21 03:32 PM



Ramachandrapuram, Andhra Pradesh, India

VSM College, Ramachandrapuram Rd,

Ramachandrapuram, Andhra Pradesh 533255, India

Lat N 16° 50' 40.4232"

Long E 82° 1' 6.2544"

15/03/21 03:33 PM



Ramachandrapuram, Andhra Pradesh, India

VSM College, Ramachandrapuram Rd,

Ramachandrapuram, Andhra Pradesh 533255, India

Lat N 16° 50' 34.854"

Long E 82° 1' 4.656"

15/03/21 03:33 PM



Ramachandrapuram, Andhra Pradesh, India

VSM College, Ramachandrapuram Rd,

Ramachandrapuram, Andhra Pradesh 533255, India

Lat N 16° 50' 34.8216"

Long E 82° 1' 4.6884"

15/03/21 03:34 PM



Ramachandrapuram, Andhra Pradesh, India

VSM College, Ramachandrapuram Rd,

Ramachandrapuram, Andhra Pradesh 533255, India

Lat N 16° 50' 35.0376"

Long E 82° 1' 4.7496"

15/03/21 03:34 PM





WATER BATH

**KEMI** WATER BATH  
HEATER  
POWER  
10 20 30 40 50 60 70 80 90 100  
OFF  
ON

VSM  
P.G. 5-10.M



Ramachandrapuram, Andhra Pradesh, India

MDR94, Ramachandrapuram, Andhra Pradesh

533287, India

Lat N 16° 50' 43.944"

Long E 82° 0' 55.2204"

15/03/21 03:34 PM

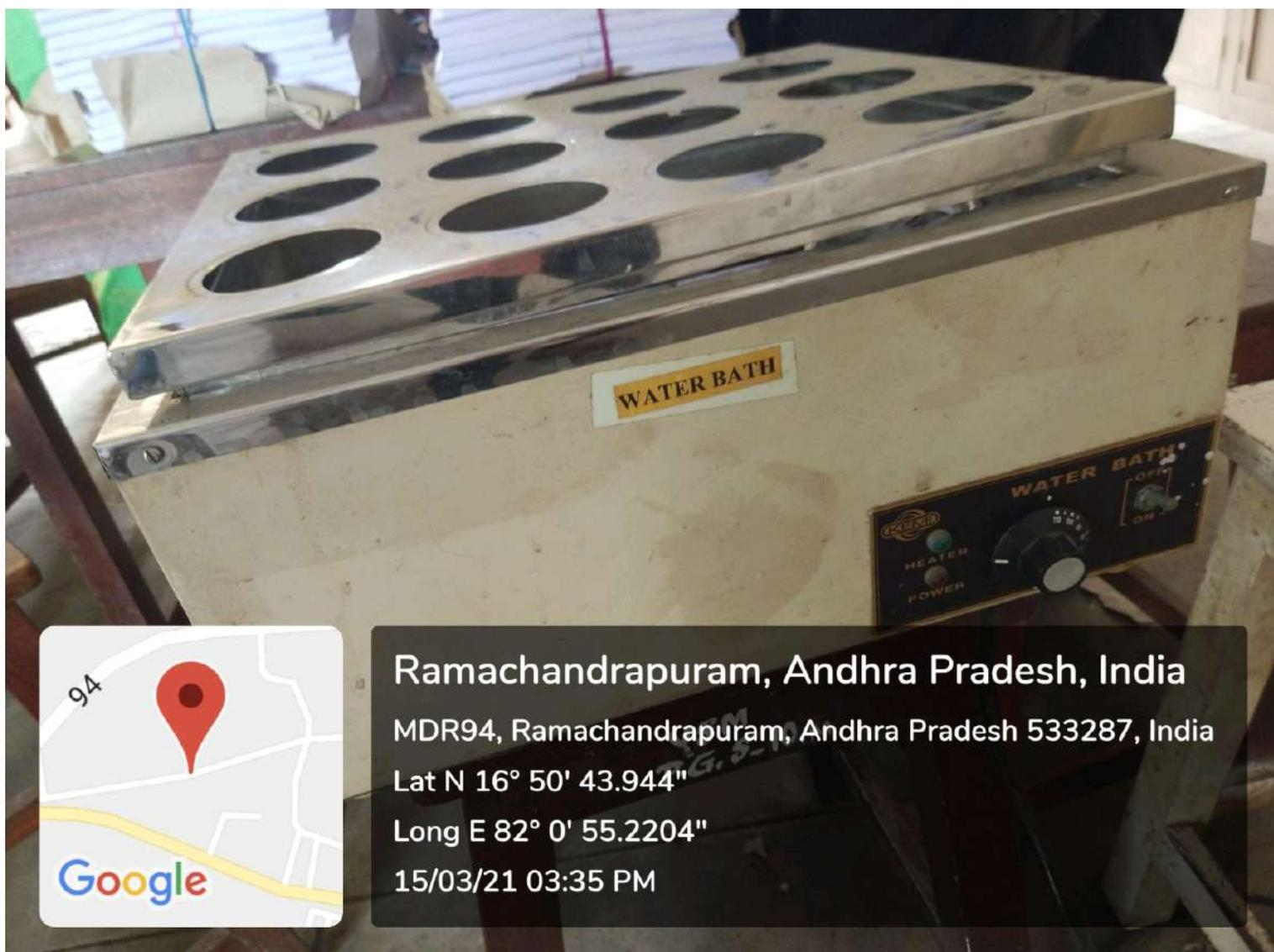

Ramachandrapuram, Andhra Pradesh, India

MDR94, Ramachandrapuram, Andhra Pradesh 533287, India

Lat N 16° 50' 43.944"

Long E 82° 0' 55.2204"

15/03/21 03:35 PM



**Ramachandrapuram, Andhra Pradesh, India**

VSM College, Ramachandrapuram Rd,

Ramachandrapuram, Andhra Pradesh 533255, India

Lat N 16° 50' 34.638"

Long E 82° 1' 6.096"

15/03/21 04:58 PM



Ramachandrapuram, Andhra Pradesh, India

VSM College, Ramachandrapuram Rd,

Ramachandrapuram, Andhra Pradesh 533255, India

Lat N 16° 50' 34.8396"

Long E 82° 1' 6.168"

15/03/21 04:59 PM



Ramachandrapuram, Andhra Pradesh, India

VSM College, Ramachandrapuram Rd,

Ramachandrapuram, Andhra Pradesh 533255, India

Lat N 16° 50' 34.98"

Long E 82° 1' 5.9952"

15/03/21 05:01 PM

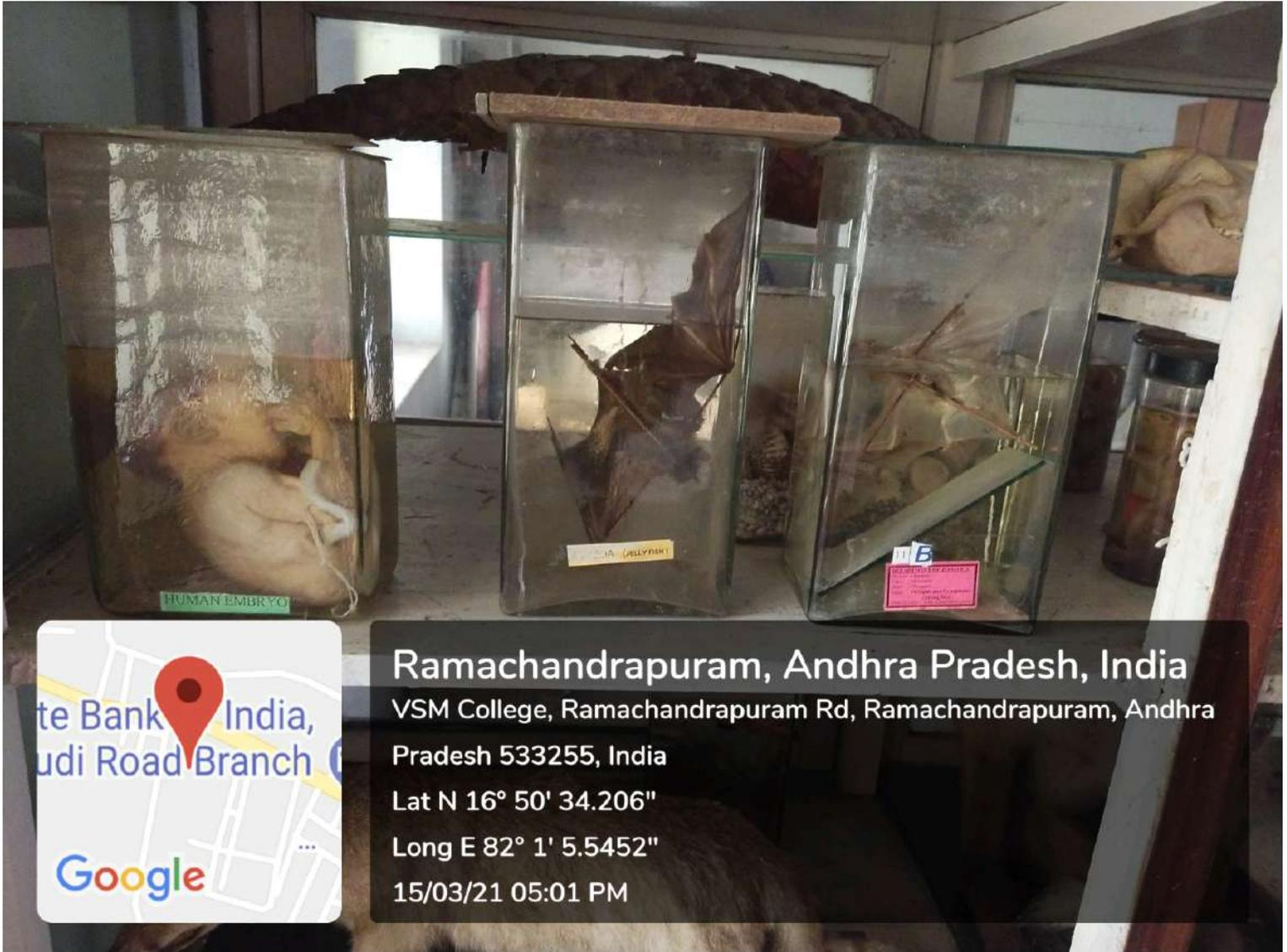

State Bank of India,  
Siddhanta Road Branch



### Ramachandrapuram, Andhra Pradesh, India

VSM College, Ramachandrapuram Rd, Ramachandrapuram, Andhra Pradesh 533255, India

Lat N 16° 50' 34.206"

Long E 82° 1' 5.5452"

15/03/21 05:01 PM



**Ramachandrapuram, Andhra Pradesh, India**

VSM College, Ramachandrapuram Rd, Ramachandrapuram, Andhra Pradesh 533255, India

Lat N 16° 50' 34.6308"

Long E 82° 1' 5.8512"

15/03/21 05:03 PM



## Ramachandrapuram, Andhra Pradesh, India

VSM College, Ramachandrapuram Rd, Ramachandrapuram, Andhra Pradesh 533255, India

Lat N 16° 50' 34.6308"

Long E 82° 1' 5.8512"

15/03/21 05:03 PM



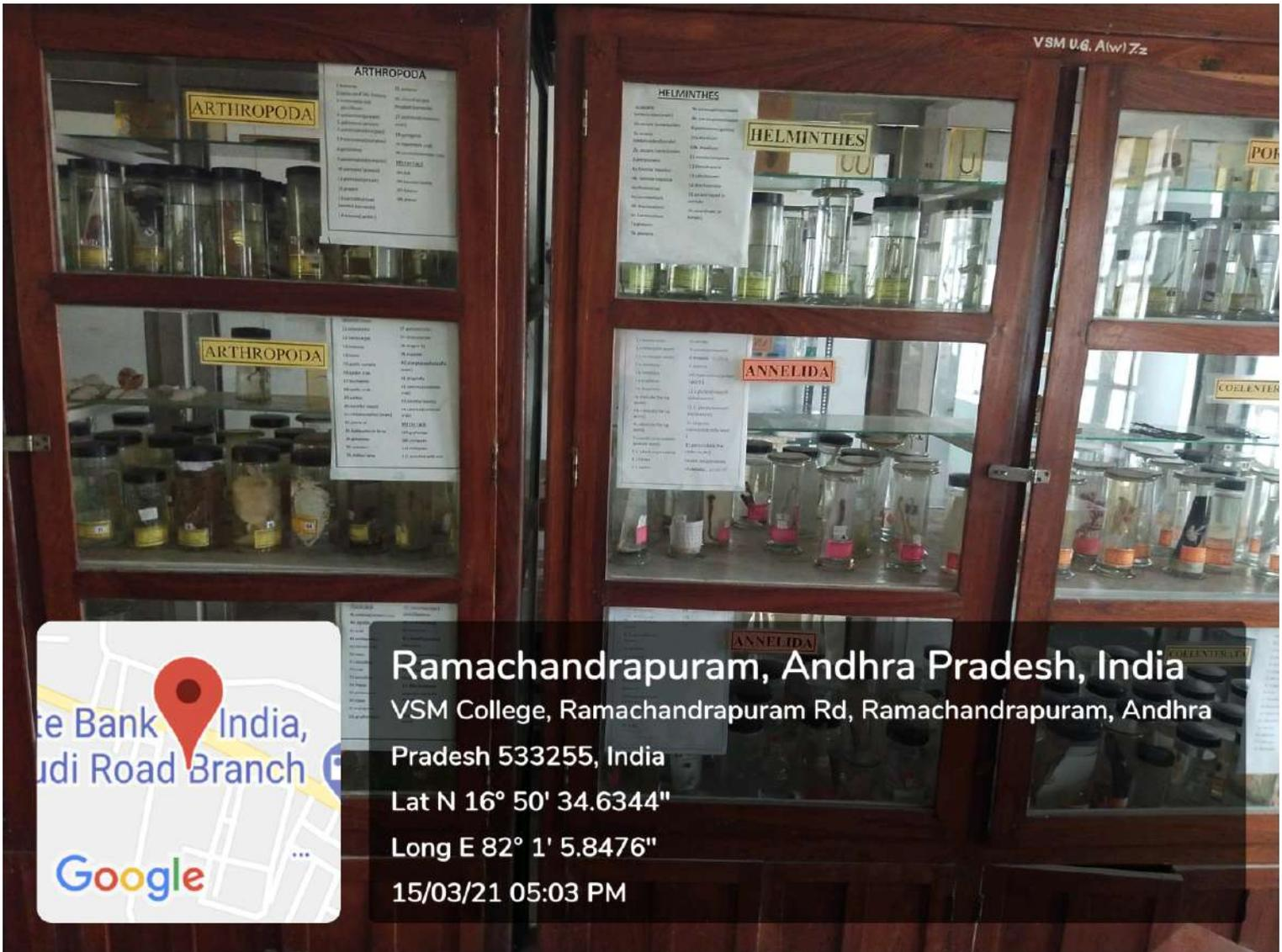

VSM U.G. Alw/ Zz

ARTHROPODA

ARTHROPODA  
1. Insecta  
2. Arachnida  
3. Crustacea  
4. Myriapoda  
5. Chilopoda  
6. Diplopoda  
7. Hexapoda  
8. Insecta  
9. Arachnida  
10. Crustacea  
11. Myriapoda  
12. Chilopoda  
13. Diplopoda  
14. Hexapoda

HELMINTHES

HELMINTHES

HELMINTHES  
1. Platyhelminthes  
2. Nematodes  
3. Trematodes  
4. Cestodes  
5. Monogeneans  
6. Platyhelminthes  
7. Nematodes  
8. Trematodes  
9. Cestodes  
10. Monogeneans

ARTHROPODA

ARTHROPODA  
1. Insecta  
2. Arachnida  
3. Crustacea  
4. Myriapoda  
5. Chilopoda  
6. Diplopoda  
7. Hexapoda  
8. Insecta  
9. Arachnida  
10. Crustacea  
11. Myriapoda  
12. Chilopoda  
13. Diplopoda  
14. Hexapoda

ANNELIDA

ANNELIDA  
1. Polychaeta  
2. Oligochaeta  
3. Hydrochaeta  
4. Polychaeta  
5. Oligochaeta  
6. Hydrochaeta  
7. Polychaeta  
8. Oligochaeta  
9. Hydrochaeta  
10. Polychaeta  
11. Oligochaeta  
12. Hydrochaeta

ANNELIDA

Ramachandrapuram, Andhra Pradesh, India

VSM College, Ramachandrapuram Rd, Ramachandrapuram, Andhra Pradesh 533255, India

Lat N 16° 50' 34.6344"

Long E 82° 1' 5.8476"

15/03/21 05:03 PM

State Bank of India, ...udi Road Branch  
Google



## Ramachandrapuram, Andhra Pradesh, India

VSM College, Ramachandrapuram Rd, Ramachandrapuram, Andhra Pradesh 533255, India

Lat N 16° 50' 34.6488"

Long E 82° 1' 5.8728"

15/03/21 05:04 PM

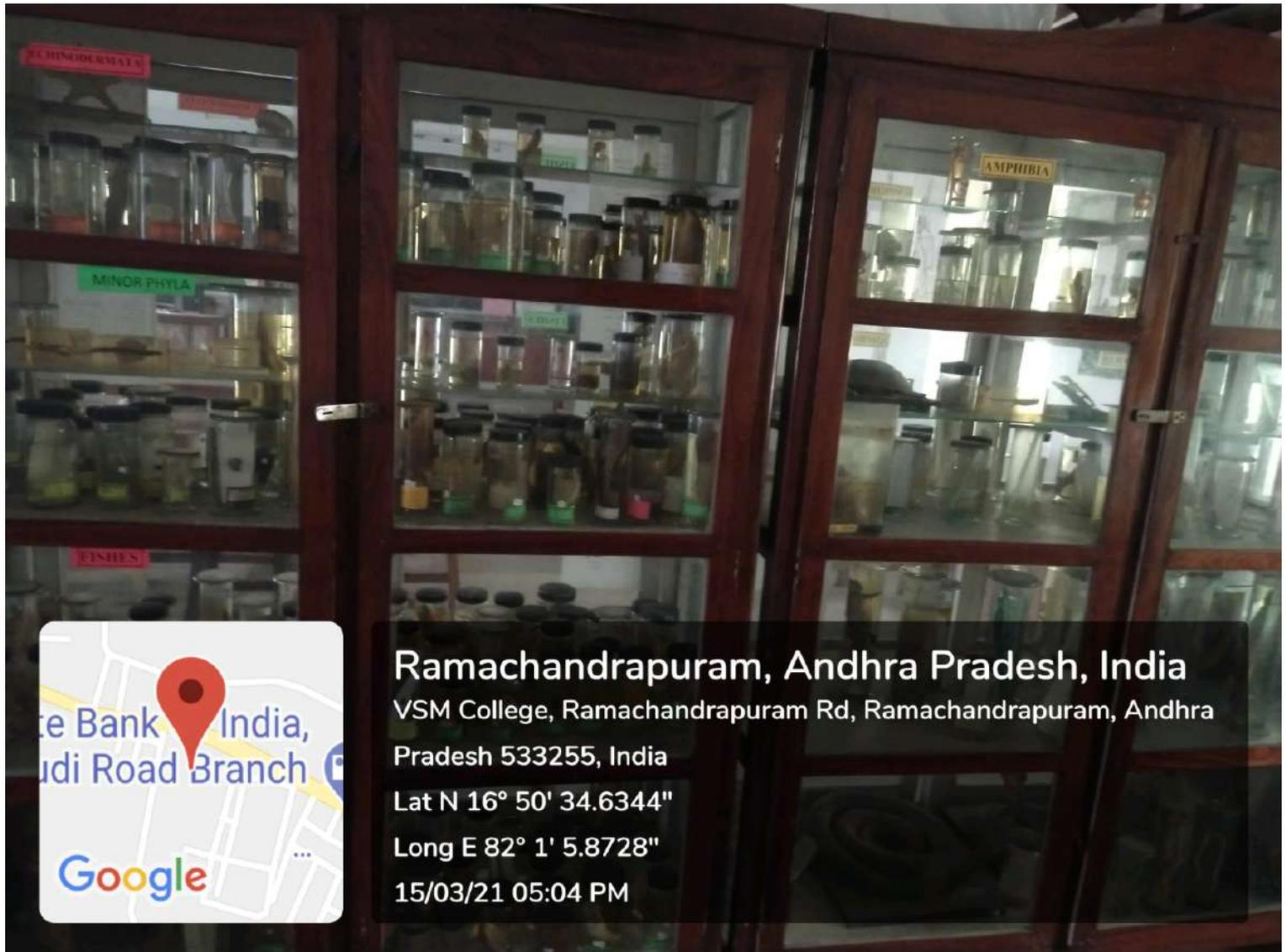

## Ramachandrapuram, Andhra Pradesh, India

VSM College, Ramachandrapuram Rd, Ramachandrapuram, Andhra Pradesh 533255, India

Lat N 16° 50' 34.6344"

Long E 82° 1' 5.8728"

15/03/21 05:04 PM



## Ramachandrapuram, Andhra Pradesh, India

VSM College, Ramachandrapuram Rd, Ramachandrapuram, Andhra Pradesh 533255, India

Lat N 16° 50' 34.6164"

Long E 82° 1' 5.8836"

15/03/21 05:04 PM



## Ramachandrapuram, Andhra Pradesh, India

VSM College, Ramachandrapuram Rd, Ramachandrapuram, Andhra Pradesh 533255, India

Lat N 16° 50' 34.4832"

Long E 82° 1' 6.0384"

15/03/21 05:06 PM



## Ramachandrapuram, Andhra Pradesh, India

VSM College, Ramachandrapuram Rd, Ramachandrapuram, Andhra Pradesh 533255, India

Lat N 16° 50' 34.4436"

Long E 82° 1' 6.0708"

15/03/21 05:06 PM



**GYMNOSPERMS**

**Ramachandrapuram, Andhra Pradesh, India**

VSM College, Ramachandrapuram Rd, Ramachandrapuram, Andhra Pradesh 533255, India

Lat N 16° 50' 34.1628"

Long E 82° 1' 7.8996"

15/03/21 05:07 PM

Bank of India,  
100 Road Branch





Ramachandrapuram, Andhra Pradesh, India

VSM College, Ramachandrapuram Rd,

Ramachandrapuram, Andhra Pradesh 533255, India

Lat N 16° 50' 34.1628"

Long E 82° 1' 7.8996"

15/03/21 05:07 PM





DEPT. OF BOTANY VSM  
ADINA CORDIFOLIA  
RAMCHANDRAPURAM

DEPT. OF BOTANY VSM  
CLEDONIA BICOLOR  
RAMCHANDRAPURAM

DEPT. OF BOTANY VSM  
OSYRIA INDICA  
RAMCHANDRAPURAM

DEPT. OF BOTANY VSM  
TITRINA ALBA  
RAMCHANDRAPURAM

DEPT. OF BOTANY VSM  
MANGIFERA INDICA  
RAMCHANDRAPURAM

Bank of India,  
Road Branch



100

Ramachandrapuram, Andhra Pradesh, India  
VSM College, Ramachandrapuram Rd,  
Ramachandrapuram, Andhra Pradesh 533255, India  
Lat N 16° 50' 34.08"  
Long E 82° 1' 8.1588"  
15/03/21 05:07 PM



Ramachandrapuram, Andhra Pradesh, India  
VSM College, Ramachandrapuram Rd,  
Ramachandrapuram, Andhra Pradesh 533255, India  
Lat N 16° 50' 41.6436"  
Long E 82° 1' 3.8028"  
15/03/21 05:07 PM

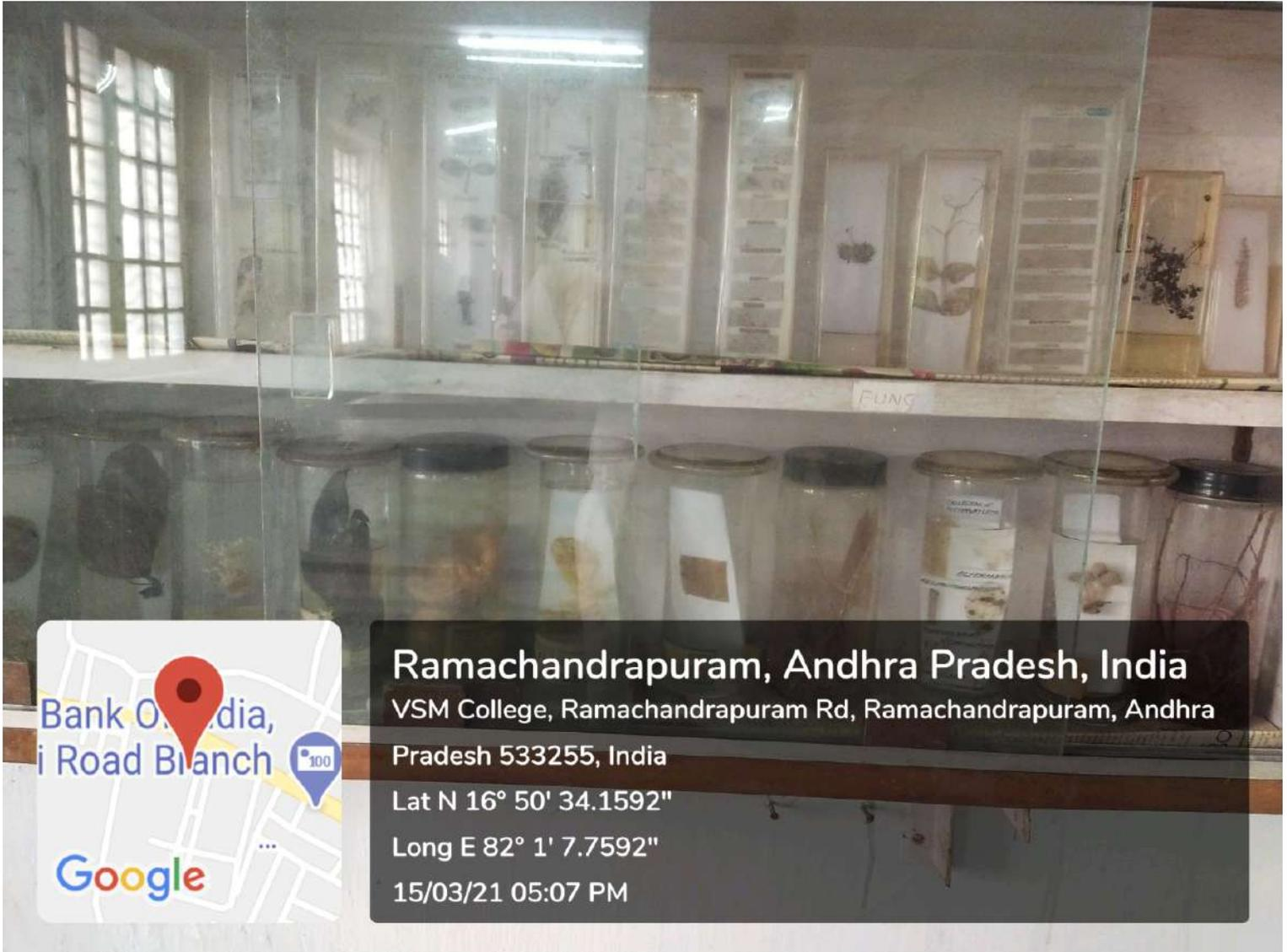

## Ramachandrapuram, Andhra Pradesh, India

VSM College, Ramachandrapuram Rd, Ramachandrapuram, Andhra Pradesh 533255, India

Lat N 16° 50' 34.1592"

Long E 82° 1' 7.7592"

15/03/21 05:07 PM



## Ramachandrapuram, Andhra Pradesh, India

VSM College, Ramachandrapuram Rd, Ramachandrapuram, Andhra Pradesh 533255, India

Lat N 16° 50' 34.1736"

Long E 82° 1' 7.77"

15/03/21 05:07 PM



Ramachandrapuram, Andhra Pradesh, India

Ramachandrapuram Rd, Ramachandrapuram,

Andhra Pradesh 533255, India

Lat N 16° 50' 40.1352"

Long E 82° 0' 58.8996"

15/03/21 05:08 PM

MORPHOLOGY



**Ramachandrapuram, Andhra Pradesh, India**

VSM College, Ramachandrapuram Rd, Ramachandrapuram, Andhra Pradesh 533255, India

Lat N 16° 50' 34.2672"

Long E 82° 1' 6.4668"

15/03/21 05:08 PM



**Ramachandrapuram, Andhra Pradesh, India**

VSM College, Ramachandrapuram Rd, Ramachandrapuram, Andhra Pradesh 533255, India

Lat N 16° 50' 34.3968"

Long E 82° 1' 6.5532"

15/03/21 05:08 PM



Ramachandrapuram, Andhra Pradesh, India  
VSM College, Ramachandrapuram Rd,  
Ramachandrapuram, Andhra Pradesh 533255, India  
Lat N 16° 50' 34.404"  
Long E 82° 1' 6.6468"  
15/03/21 05:09 PM



V.S.M.C. F.38

MORPHOLOGY



Ramachandrapuram, Andhra Pradesh, India

VSM College, Ramachandrapuram Rd,

Ramachandrapuram, Andhra Pradesh 533255, India

Lat N 16° 50' 34.404"

Long E 82° 1' 6.6468"

15/03/21 05:09 PM



VSM  
U.G. Aw/ 12 B

ALGAE

ALGAE

ALGAE

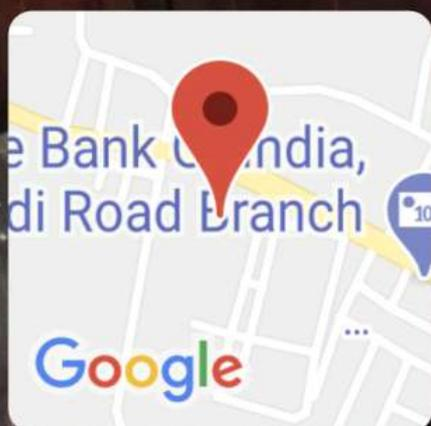

Ramachandrapuram, Andhra Pradesh, India

VSM College, Ramachandrapuram Rd,

Ramachandrapuram, Andhra Pradesh 533255, India

Lat N 16° 50' 34.4508"

Long E 82° 1' 6.6396"

15/03/21 05:09 PM



VSM  
U.G. Alw/13B

FUNGI

PERIDOPHYTA

PERIDOPHYTA

PERIDOPHYTA

PERIDOPHYTA



Ramachandrapuram, Andhra Pradesh, India

VSM College, Ramachandrapuram Rd,

Ramachandrapuram, Andhra Pradesh 533255, India

Lat N 16° 50' 34.4688"

Long E 82° 1' 6.6396"

15/03/21 05:09 PM



VSM  
U.G. A(W)13B

FUNGI

PTERIDOPHYTA

PTERIDOPHYTA

PTERIDOPHYTA

PTERIDOPHYTA

e Bank India,  
di Road Branch

Google

Ramachandrapuram, Andhra Pradesh, India  
VSM College, Ramachandrapuram Rd,  
Ramachandrapuram, Andhra Pradesh 533255, India  
Lat N 16° 50' 34.4688"  
Long E 82° 1' 6.6396"  
15/03/21 05:09 PM

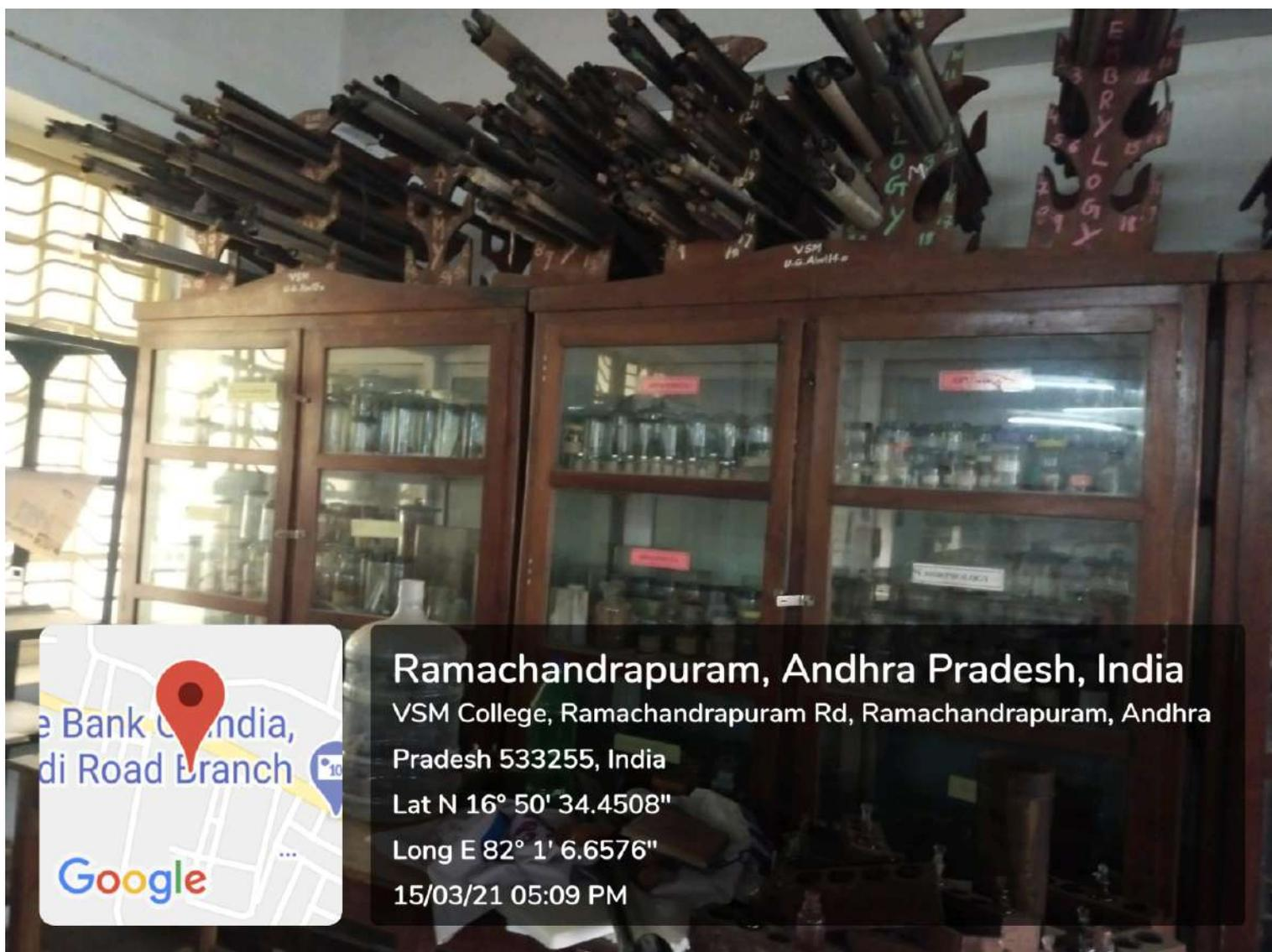

## Ramachandrapuram, Andhra Pradesh, India

VSM College, Ramachandrapuram Rd, Ramachandrapuram, Andhra Pradesh 533255, India

Lat N 16° 50' 34.4508"

Long E 82° 1' 6.6576"

15/03/21 05:09 PM

e Bank of India,  
di Road Branch

Google



BRYOPHYTA



### Ramachandrapuram, Andhra Pradesh, India

VSM College, Ramachandrapuram Rd, Ramachandrapuram, Andhra Pradesh 533255, India

Lat N 16° 50' 34.3896"

Long E 82° 1' 6.726"

15/03/21 05:10 PM



**Ramachandrapuram, Andhra Pradesh, India**

Ramachandrapuram Rd, Ramachandrapuram, Andhra Pradesh  
533255, India

Lat N 16° 50' 42.9612"

Long E 82° 1' 3.8028"

15/03/21 05:10 PM



**Ramachandrapuram, Andhra Pradesh, India**

VSM College, Ramachandrapuram Rd, Ramachandrapuram, Andhra Pradesh 533255, India

Lat N 16° 50' 34.3752"

Long E 82° 1' 6.8772"

15/03/21 05:10 PM





## Ramachandrapuram, Andhra Pradesh, India

VSM College, Ramachandrapuram Rd, Ramachandrapuram, Andhra Pradesh 533255, India

Lat N 16° 50' 34.3644"

Long E 82° 1' 6.7584"

15/03/21 05:10 PM



## Ramachandrapuram, Andhra Pradesh, India

VSM College, Ramachandrapuram Rd, Ramachandrapuram, Andhra Pradesh 533255, India

Lat N 16° 50' 34.3896"

Long E 82° 1' 6.7728"

15/03/21 05:11 PM



Ramachandrapuram, Andhra Pradesh, India

VSM College, Ramachandrapuram Rd,

Ramachandrapuram, Andhra Pradesh 533255, India

Lat N 16° 50' 34.404"

Long E 82° 1' 6.8088"

15/03/21 05:11 PM

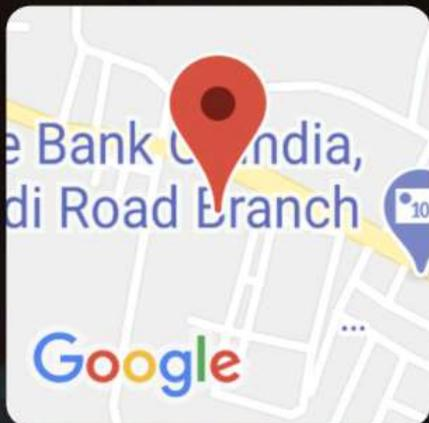

Ramachandrapuram, Andhra Pradesh, India

VSM College, Ramachandrapuram Rd,

Ramachandrapuram, Andhra Pradesh 533255, India

Lat N 16° 50' 34.4616"

Long E 82° 1' 6.7368"

15/03/21 05:12 PM



## Ramachandrapuram, Andhra Pradesh, India

VSM College, Ramachandrapuram Rd, Ramachandrapuram, Andhra Pradesh 533255, India

Lat N 16° 50' 34.0512"

Long E 82° 1' 6.744"

15/03/21 05:13 PM



Bank of India,  
VSM Road Branch

Google

Ramachandrapuram, Andhra Pradesh, India  
VSM College, Ramachandrapuram Rd,  
Ramachandrapuram, Andhra Pradesh 533255, India  
Lat N 16° 50' 33.828"  
Long E 82° 1' 7.1616"  
15/03/21 05:14 PM



Bank of India,  
...li Road Branch

Google

Ramachandrapuram, Andhra Pradesh, India  
VSM College, Ramachandrapuram Rd,  
Ramachandrapuram, Andhra Pradesh 533255, India  
Lat N 16° 50' 34.098"  
Long E 82° 1' 7.2732"  
15/03/21 05:14 PM



Ramachandrapuram, Andhra Pradesh, India  
VSM College, Ramachandrapuram Rd,  
Ramachandrapuram, Andhra Pradesh 533255, India  
Lat N 16° 50' 33.6624"  
Long E 82° 1' 7.9572"  
15/03/21 05:14 PM





Bank Of India,  
li Road ch

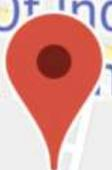

Google

Ramachandrapuram, Andhra Pradesh, India

Om Sri Towers Rd, Ramachandrapuram, Andhra

Pradesh 533255, India

Lat N 16° 50' 30.9516"

Long E 82° 1' 7.41"

15/03/21 05:15 PM



## Ramachandrapuram, Andhra Pradesh, India

VSM College, Ramachandrapuram Rd, Ramachandrapuram, Andhra Pradesh 533255, India

Lat N 16° 50' 32.5248"

Long E 82° 1' 7.392"

15/03/21 05:15 PM



## Ramachandrapuram, Andhra Pradesh, India

VSM College, Ramachandrapuram Rd, Ramachandrapuram, Andhra Pradesh 533255, India

Lat N 16° 50' 32.6832"

Long E 82° 1' 7.1904"

15/03/21 05:16 PM